

Application of Four Wire UPQC System to Micro Grid for Power Quality Improvement

S. Krishnarjuna Rao, G. Naga Raju

Department of Electrical & Electronics Engineering, M.Tech, Assisatnt professor,
Narasaraopet Engineering college, Guntur, Andhra Pradesh, India
Email: s.krishnarjuna@gmail.com, nagaraj204@gmail.com

Abstract:- This paper proposes FACT device for Microgrid applications. This device is used to improve the reliability and power quality of the overall micro grid loads. In order to obtain faster computational time for large power systems, by resolving the steady-state and the transient control problems separately, a novel control design used in this new model of control algorithm. To demonstrate the capability of the proposed flexible ac distribution system device this design concept is verified through different test case scenarios and the results obtained are discussed.

I. INTRODUCTION

A Microgrid is a localized grouping of electricity generation, energy storage, and loads that normally operate connected to a traditional centralized grid (macrogrid) and microgrid has offered consumers with reduction in total energy losses, and with increased reliability and has become an alternative for traditional power distribution system

The impact of power quality (PQ) problems on the overall power system performance depends on concepts of a microgrid distribution grid. These power quality problems dependent on some of the electrical parameters like voltage and frequency. In order to overcome power quality problems, some of powerconditioning devices such as active filters, dynamic voltage restorers (DVR), uninterruptible power supplies (UPS), and several unified PQ conditioners are usually employed by users to protect their loads and systems against power quality disturbances in the overall power system. , these equipments are usually installed at the load sides

This concept proposes a FACT device for the microgrid that is realized using a combination of series and Parallel voltage source inverters. The proposed flexible ac distribution system device is connected at the PCC of the distribution network that the microgrid and other loads are connected to. In this project sources are a photovoltaic (PV) array and a battery to store the excess energy generated by the PV array and to provide power during sunless hours. By use of this device we can get improved the Power Quality and reliability of the microgrid.

The proposed Fact device can provide active and reactive power to the microgrid. To track periodic reference signals for fast sampling linear time invariant

systems that are subject to input, in this project a modified controller is based on a newly developed model predictive control algorithm. This project steady-state and transient sub problems which are optimized separately. In this way, so that computational times can be reduced greatly.

This concept provides a comprehensive solution for the operation of the Fact device for a microgrid based on a multi-input–multi-output statespace model. The Fact device will accomplish the following tasks simultaneously

- 1) Limiting harmonics in the grid voltage and load currents;
- 2) Active and reactive power control for load sharing during peak periods and power Factor correction at the grid side;
- 3) Maintaining Power Quality problem slight voltage and frequency variations in the grid voltage
- 4) Momentarily output active and reactive power to the microgrid when it becomes islanded.

II. SYSTEM DESCRIPTION

The configuration proposed Fact device is shown below. The proposed microgrid consists of three feeders here feeders 1 and 3 are each connected to a DG unit consisting of a Micro generator, a threephase Voltage Source Inverter, and a three-phase LC filter. Feeder 2 is connected to a load.. The Fact device is operated in two modes: 1) Power Quality compensation and 2) important emergency operation. During grid-connected operation, the microgrid is connected to the distribution grid at the Point of Common Coupling. In this mode, the two distributed generation units are controlled to provide local power and voltage support for loads 1–3 and hence reduce the load of generation and delivery of Power directly from the utility grid. The FACT device functions to Limit harmonics in the currents drawn by the several loads in the microgrid so that the harmonics will not effected to the rest of the loads that are connected to the Point of Common Coupling.

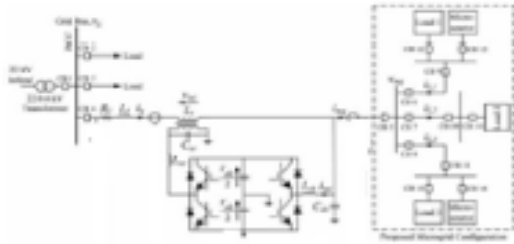

Fig. 1: Configuration of the proposed Fact device and the microgrid architecture.

The device also functions to limit harmonics in the grid voltage that are caused by other loads that are connected at the Point of Common Coupling. Because of The activation of large loads and rapid changes in the demand may also result in voltage and frequency variations in the grid voltage. Therefore, the Fact device is also equipped with the capability to

handle such v and f variations. When a fault occurs the circuit breaker is operate to isolate the microgrid from the grid. The distributed generation units are now the important power sources to regulate the loads. If the micro generators is unable to meet the total load demand, the Fact device is operate in the emergency mode and provide for the required in active and reactive power. The detailed configuration of the three Fact device is shown.

III. FLEXIBLE AC DISTRIBUTION SYSTEM DEVICE MODEL

The single-phase representation of the Fact device is shown the distribution grid average voltage at the Point of Common Coupling and the total current drawn represented as v_g and img , respectively. both voltage v_g and current drawn img could be distorted due of harmonic. Therefore, voltage v_g is modeled as a source consisting of its fundamental v_f and harmonic v_h given as

$$v_g = v_f + v_h = V_f \sin(\omega t) + \sum_{h=3,5,\dots}^N V_h \sin(h\omega t - \theta_h) \quad (1)$$

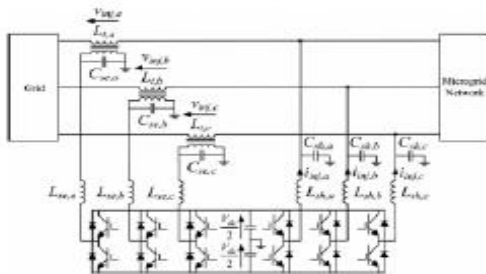

Fig. 2: Representation of the three-phase flexible ac distribution system device

Here v_f is the fundamental component of v_g with its peak amplitude V_f and v_h is a combination of the harmonic components of v_g with its peak amplitude V_h and phase angle θ_h . To limit the harmonics in v_g , the series VSI injects a voltage v_{inj} that is given by

$$v_{inj} = v_h - v_z - v_t$$

where, v_t is the voltage drop across the equivalent leakage reactance L_t of the series-connected transformer, and v_z is the voltage drop across the line impedance of R and L .

IV. CONTROL DESIGN

The control of the UPQC system has been divided into two parts, one as the series active filter and the other is shunt active filter. Each control has its own and individual closed loop function in order to control the VSCs on the shunt side and series sides of the micro grid system.

a. Series controller:

The block diagram of a series controller is shown in fig. 3

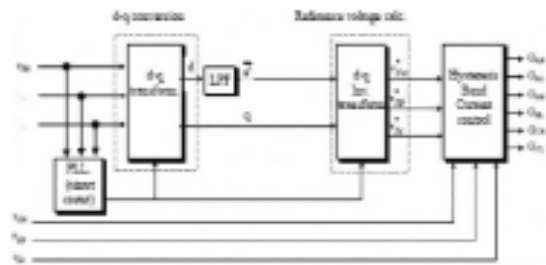

Fig 3. Series controller block diagram

In the model we are utilizing a PLL for synchronization of the series APF to the system. And with the use of parks transformation we are obtaining dq0 parameters from abc, in order the redefine the direct and quadrature axis components of the system. The equations used in the system are,

$$U_s = u_d + j \cdot u_q = (u_a + j \cdot u_b) \cdot e^{-j\omega t} = \frac{2}{3} \left(u_a + u_b \cdot e^{j\frac{2\pi}{3}} + u_c \cdot e^{j\frac{4\pi}{3}} \right) \cdot e^{-j\omega t}$$

$$u_0 = \frac{1}{3}(u_a + u_b + u_c)$$

$$\begin{bmatrix} u_d \\ u_q \\ u_0 \end{bmatrix} = \frac{2}{3} \begin{bmatrix} \cos(\omega t) & \cos(\omega t - \frac{2\pi}{3}) & \cos(\omega t + \frac{2\pi}{3}) \\ -\sin(\omega t) & -\sin(\omega t - \frac{2\pi}{3}) & -\sin(\omega t + \frac{2\pi}{3}) \\ \frac{1}{2} & \frac{1}{2} & \frac{1}{2} \end{bmatrix} \begin{bmatrix} u_a \\ u_b \\ u_c \end{bmatrix}$$

The voltage requirement is calculated by using the inverse parks transformation after the LPF from the direct axis component to reduce the ripple in the generated reference current. Pulses produced by the generator are given to the IGBT inverter which induces voltage into the system.

b. Shunt control:

In order to reduce the harmonic distortion caused in the system due to non-linear loads we introduce a shunt active power filter to inject reactive power into the system by consuming leading current, and that is done by putting a capacitor at the dc-link between the series

and shunt VSCs. The block diagram of the control is shown below,

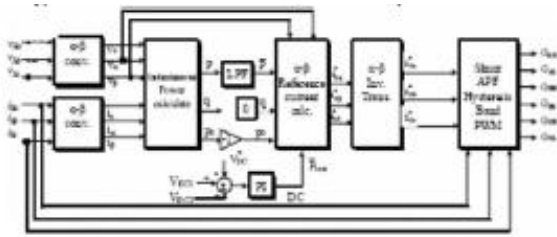

Fig. 4: shunt APF control

With the use of Parks and clarks transformations we generate the required power 'p' and 'q' by which this method is also considered to be as 'p-q theory' or 'irp theory'. The equations used for the transformation are

$$\begin{bmatrix} u_{\alpha} \\ u_{\beta} \\ u_0 \end{bmatrix} = \begin{bmatrix} \frac{2}{3} & \frac{1}{3} & \frac{1}{3} \\ 0 & \frac{1}{\sqrt{3}} & \frac{1}{\sqrt{3}} \\ \frac{1}{3} & \frac{1}{3} & \frac{1}{3} \end{bmatrix} \begin{bmatrix} u_a \\ u_b \\ u_c \end{bmatrix} \quad \begin{bmatrix} u_a \\ u_b \\ u_c \end{bmatrix} = \begin{bmatrix} 1 & 0 & 1 \\ -\frac{1}{2} & \frac{\sqrt{3}}{2} & 1 \\ -\frac{1}{2} & -\frac{\sqrt{3}}{2} & 1 \end{bmatrix} \begin{bmatrix} u_{\alpha} \\ u_{\beta} \\ u_0 \end{bmatrix}$$

The generated pulses from the transformation are thus given to the shunt APF so as to inject reactive power into the micro grid system.

V. RENEWABLE ENERGY RESOURCES

Utilization of renewable energy resources has been increased in today's technology. In order to maintain the demand we are opting for these kind of sources and also due to the depletion of fossil fuels. We are using the solar power as Photo voltaic array as the most efficient renewable source. The design of renewable source in MATLAB is shown in the figure below.

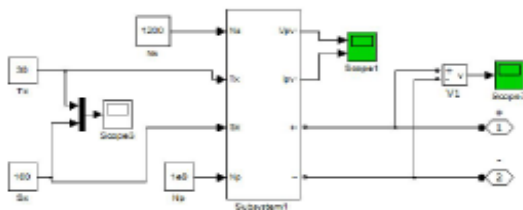

Fig. 5: PVA in simulink model

The formulation used for the construction is given as

$$V_C = \frac{AKT_C}{q} \ln \left(\frac{I_{ph} + I_0 - I_C}{I_0} \right) - I_C R_S$$

These renewable energy PVA sources are used as micro grid sources which are in turn connected to inverters and filters so as to connect to the grid system in inject power for the local loads.

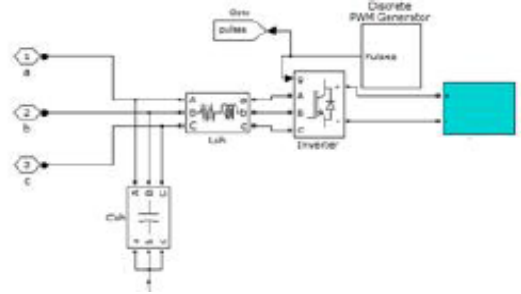
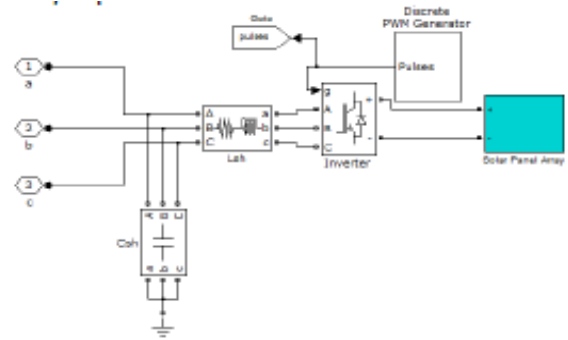

Fig. 6: Inverter connection of PVA& Fuel Cell

VI. UPQC SYSTEM DESIGN

With all the control structures and active power filters we are now constructing a four wire UPQC system as shown in the fig. below

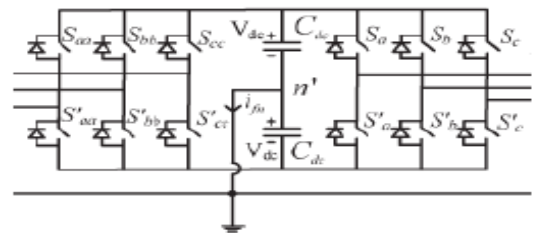

Fig. 7: Four wire UPQC system

We have a dc link capacitors of two where the midpoint is connected to ground. The left APF is series and the right is shunt. We use IGBT and a parallel diode as a switch.

VII. SIMULATION AND RESULTS

The simulation is carried out in MATLAB 7.14 and the design of the total grid system is shown in fig 8. As we can see the system comprises of a normal source grid connected to a micro grid ie, one PVA and one Fuel cell. We also connected the linear and nonlinear loads to the system which causes sag and harmonics in the system. A four wire UPQC is attached in the middle with a circuit breaker connected to the point of common coupling which injects voltage and reactive power into the system.

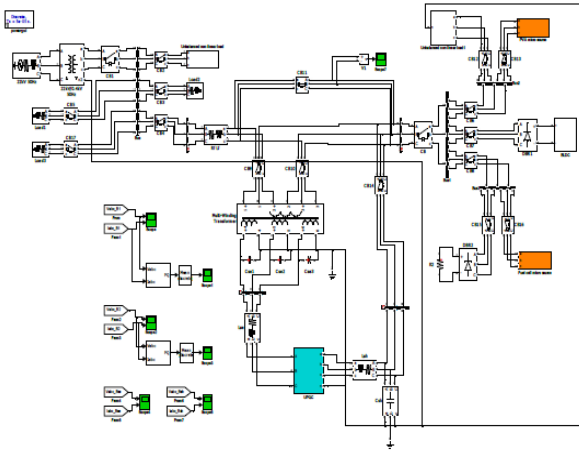
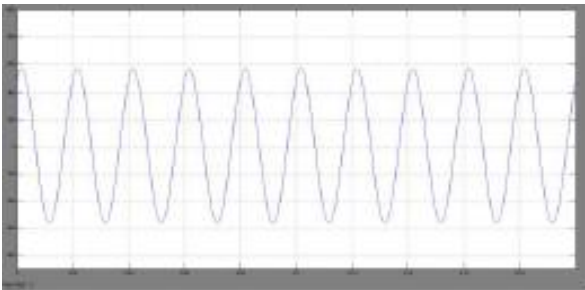
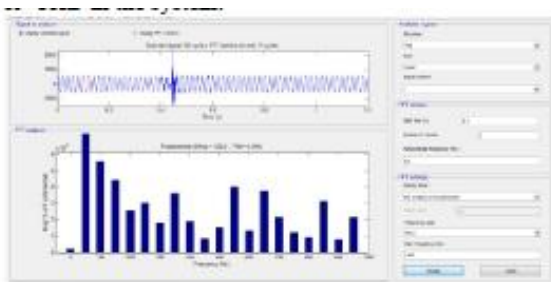

Fig8: Grid Connected UPQC system

The simulation is run for 1.2 sec and the operation is observed. In the below figure you can see the voltage at the PCC (Point of common coupling) from 0-0.2 sec.



And the total harmonic distortion of the above waveform is shown below. As we can see the THD is 0.00% that is because we have not connected any load or micro grids to the system, so we don't have any sag or THD in the system.



Now we add linear and non-linear loads on the grid side of the system and see the voltage mag difference and THD ie., from 0.2 to 0.4 sec

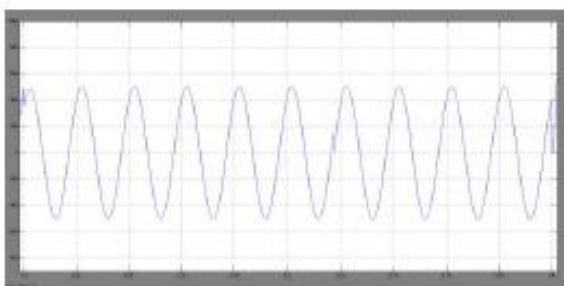

As we can observe there is no THD change in the system due to less non-linear loads but there is a sag created due to load demand on the source

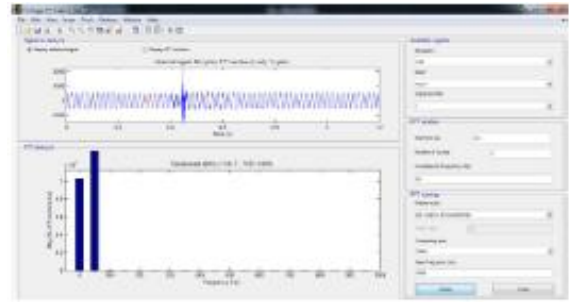

And now at 0.4sec we attach the micro grid to the system so as to observe the differences in the system. The model now introduces THD in the system with voltage sag.

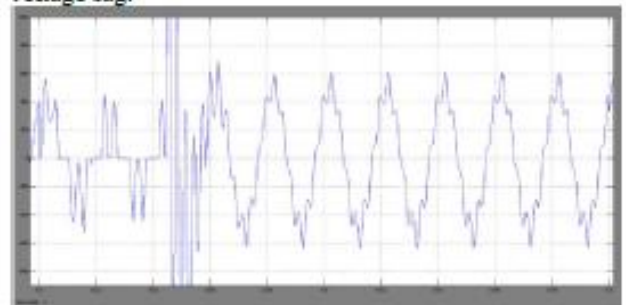

The THD and the voltage are at 17.83% and 505.4 V (L-L) peak value.

The system is now has lost total quality and we have to maintain the systems quality by introducing the four wire UPQC model. So, at time 0.6sec we attach the UPQC to the system with the help of a circuit breaker and observe the difference in the model.

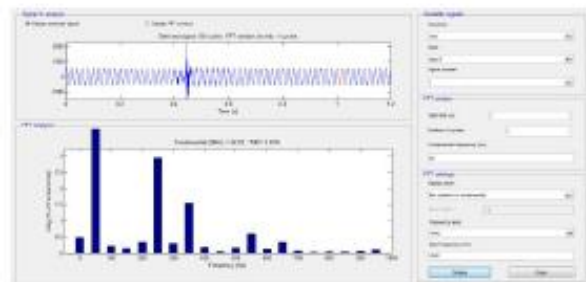
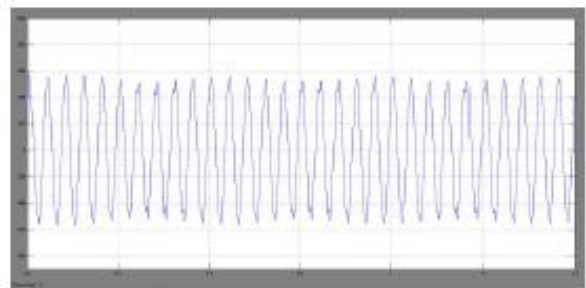

As we can see the THD and the voltage are again maintained at 3.45% and 543.8 V (L-L) peak value

respectively. So, we determine that the voltage profile of the system is improvised by connecting an UPQC to the system at the PCC.

VIII. CONCLUSION

In this proposed configuration of a Fact device for Microgrid applications has been presented. The proposed solution integrates extended Kalman filter into the control design for frequency tracking, and to limit the harmonics of grid voltage and currents. The device is installed at the point of common coupling that the Microgrid and is designed to overcome power quality issues. It is operates as a distributed generation unit under emergency condition. The design configuration is simulated and tested using matlab simulink software so that the flexible ac distribution system device is able to tackle a wide range of Power Quality problems, finally with this Fact device Power Quality and reliability The simulation results obtained in this paper and the current analysis serve as a fundamental step toward the design of control circuits for hardware implementation of the device in the future.

REFERENCES

- [1] I. H. Altas and A.M. Sharaf "a photovoltaic array simulation model for matlab-simulink gui environment" 1-4244-0632- 3/07/\$20.00 ©2007 IEEE.
- [2] Sharad W. Mohod, Member, IEEE, and Mohan V. Aware" a statcom-control scheme for grid connected wind energy system for power quality improvement" IEEE SYSTEMS JOURNAL, VOL. 4, NO. 3, SEPTEMBER 2010
- [3] S.F. Torabi D. Nazarpour Y. Shayestehfard "compensation of sags and swells voltage using dynamic voltage restorer (dvr) during single line to ground and three-phase faults" ISSN 2077-3528 IJTPE Journal
- [4] A.Jeraldine Viji\Dr.M.Sudhakaran2 Asst. Professor, Research scholar!, MEC,JNTU, Associate pro-f ,PEC" Generalized UPQC system with an improved Control Method under Distorted and Unbalanced Load Conditions" 2012 International Conference on Computing, Electronics and Electrical Technologies [ICCEET]
- [5] Vishal Verma, Member IEEE, Amritesh Kumar Department of Electrical Engineering, Delhi Technological University" Grid Connected Single Phase Rooftop PV System with Limited Reactive Power Supply" IEEE TRANSACTIONS ON POWER AND ENERGY CONTROL, Volume:28 , Issue: 1, FEB2013
- [6] Mukhtiar Singh, Student Member, IEEE, Vinod Khadkikar, Member, IEEE, Amrisha Chandra, Senior Member, IEEE, and Rajiv K. Varma, Senior Member, IEEE" Grid Interconnection of Renewable Energy Sources at the Distribution Level With Power- Quality Improvement Features" IEEE TRANSACTIONS ON POWER DELIVERY, VOL. 26, NO. 1, JANUARY 2011
- [7] Sajid Ali, Yogesh K Chauhan, Bhavnesh Kumar" Study & Performance of DVR for Voltage Quality Enhancement" 978-1-4673- 6150-7/13/\$31.00 ©2013 IEEE
- [8] Fawzi AL Jowder,"Modeling and Simulation of Dynamic Vltage Restorer (DVR) Based on Hysteresis Vltage Control" 1-4244-0783-4/07/\$20.00 c2007 IEEE
- [9] R. H. Salimin, M. S. A. Rahim" Simulation Analysis of DVR Performance for Voltage Sag Mitigation" 978-1-4577-0354- 6/11/\$26.00 ©2011 IEEE
- [10] Dr. Abu Tariq, Mohammed Asim and Mohd.Tariq" Simulink based modeling, simulation and Performance Evaluation of an MPPT for maximum power generation on resistive load" IPCBEE vol.6 (2011) © (2011) IACSIT Press, Singapore [11] juha turunen "series active power filter in power conditioning"1- 4244-0632-3/07/\$20.00 ©2007 iee.

